

# **GBA HR1 Operation Manual**

**Contents:**

Introduction	3
Connections	4
Interface Specification	5
Maximum Values	5
Environmental	5
Power Supply	6
Servicing the Validator	7
Cleaning the note path	7
Jam Clearance	8
Calibration	9
Configuration using the programming card	10
Configuration using GBATalk PC software	10
Product options	10
Changing the EPROM	12
Reprogramming via FLASH	12
Unit to unit Cloning	13
Changing a Note Guide	14
Optical Anti String Gate (OASG) Description	15
GBA HR1 Default Configuration	17
Diagnostics	18
Diagrams	21
Revision Data and Contact Details	23

# GBA *Global Bill Acceptors*    GBA HR1 Operation Manual

## **Introduction:**

This manual describes the operation and basic servicing of the GBA HR1 note validator.

If you have any questions about this or any other Astrosys products then please visit our web sites at [www.globalbillacceptors.com](http://www.globalbillacceptors.com) and [www.microcoin.com](http://www.microcoin.com), or contact your local sales office for assistance (see last page).

The GBA HR1 has been specially designed to fit into all applications previously served by the GBA note validator range, including Vending, Amusement, Parking, and Internet kiosks. The GBA HR1 can operate as a head only unit as well as fitting existing stacker configurations. The following features are also offered:

- Superior note discrimination
- Up to 16 note x 4 way acceptance
- Accepts notes from 61 to 82mm wide (and up to 170mm in length)
- Escrow
- Manufactured to ISO 9001 standards
- Simple configuration using Programming Card or PC software
- Internal Optical Anti String Gate as standard
- Optional external Mechanical Anti String Gate
- Modular hardware
- 12V (+/- 10%) operation
- Easy access to note path for servicing and cleaning
- On board bi-colour diagnostic LED
- Automatic temperature compensation
- Red illuminated runway note guide fitted as standard

## Connections:

Please note: care should be taken to avoid reversing the Ground and 12VDC connections, as this will cause damage to the unit.



Pin		Parallel	Mars Serial	Pulse	Serial (R1)
1	Grey	/ABN Output	/ABN Output	/ABN Output	n.c.
2	Orange	n.c.	/Serial Select (Low)	Pulse (High) or n.c.	n.c.
3	White	/Vend 6 Output	/Busy	/Busy	n.c.
4	Yellow	/Escrow control	Clears /ABN and Stacker Full Signal	Clears /ABN and Stacker Full Signal	n.c.
5	Green	/ Vend 5 Output	TXD	n.c.	TXD
6	Brown	n.c.	Serial Send Signal (/RTS)	n.c.	n.c.
7	Black	/ Vend 3 Output	Gnd	n.c.	n.c.
8	Red	/ Vend 4 Output	n.c.	n.c.	n.c.
9	Whi/Blk/Grn	n.c.	n.c.	n.c.	RXD
10	Blue	Inhibit Control Input (/Enable)	Inhibit Control Input (/Enable)	Inhibit Control Input (/Enable)	n.c.
11	Violet	/ Vend 1 Output	Confirm Signal To Start Serial (/CTS)	n.c.	n.c.
12	Whi/Vio	n.c.	n.c.	/Pulse O/P	n.c.
13	Whi/Gry	/ Vend 2 Output	n.c.	n.c.	n.c.
14	Whi/Blk	Motor Ground	Motor Ground	Motor Ground	Motor Ground
15	Whi/Blk	Ground	Ground	Ground	Ground
16	Whi/Red	12 VDC +	12 VDC +	12 VDC +	12 VDC +
17	Whi/Red	12 VDC +	12 VDC +	12 VDC +	12 VDC +
18	Whi/Yel	PDT Terminal	PDT Terminal	PDT Terminal	PDT Terminal
19	Whi/Grn	PDT Terminal	PDT Terminal	PDT Terminal	PDT Terminal
20	Whi/Blu	PDT Terminal	PDT Terminal	PDT Terminal	PDT Terminal

Note: where a description is preceded by a “/” then that signal is active low.  
n.c. = not connected

See also Interface Description Manual for further details.

## Interface Specification

Maximum Output Low Voltage	0.4VDC
Minimum Output High Voltage	2.4VDC
Maximum output sink current (Open collector)	50mA @ 12VDC
Input pull up to 5V	21K ohm

Signal	Description
/ABN (Alarm)	Output – low for 100ms (parallel interface) or permanently low to indicate error or alarm in serial and pulse interfaces.
/VEND n	The vend outputs 1 to 6 (parallel interface) are capable of sinking up to 50 MA at 12VDC.
/ESCROW	Input - when low this selects Escrow mode
PULSE , /SERIAL select	Input - when low selects Mars® Serial (A) mode. High or not connected selects pulse mode
/BUSY	Output – a low output indicates when the acceptor is operating
/DATA	Output - used to send data to the host machine
/CTS	Input - from host that tells acceptor that host is ready to receive the message
/Enable	Input - Determines whether or not the acceptor will accept bills. Logic low = accept bills
/RTS (Interrupt)	Output to host signal that the acceptor wishes to send a message to the host.
/PULSE O/P	The pulse credit output is capable of sinking up to 50 MA at 12VDC.  The pulse pattern is selectable via the programming card. In the normal mode the pattern is 50mS on/300ms off. In the fast mode a 50mS/50mS pattern results.
TXD	Output – open collector
RXD	Input - TTL level RS232 receive data

### Absolute Maximum Specifications:

**Input Voltage**                    **13.2VDC**  
**Signal Input High Voltage**   **5.5VDC**

Minimum Specifications  
Input Voltage                        10.8VDC  
Signal Minimum Voltage         0V

### Environmental

Humidity	min	5%
	max	95% (non condensing)
Temperature	min	0 °C
	max	+60°C

## Supply

Voltage	12VDC +/- 10%
Current consumption	
Quiescent	180 mA
Validating	750 mA
Stalled	1.5A

## I/O Drivers

Signal interfaces are buffered by use of Toshiba TD6283 or equivalent.

The outputs are open collector.

Inputs:

- High > 3.5 V
- Low < 0.3 V

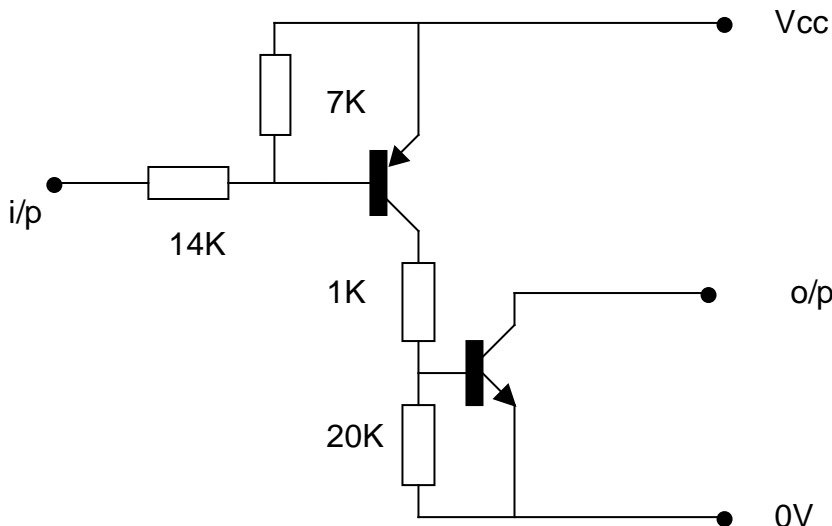

### 6283 Schematic

### ccTalk® Connection

If the validator is used in a ccTalk® interface application, an additional harness is required.

Part Number: **HCC**

Please contact Technical Support for details.

### MDB Connection

If the validator is used in an MDB interface application, an additional power supply or conversion board is required.

Part Number: **PSU5G** – MDB power supply

Part Number: **Z/MDBBLK** – MDB conversion board.

Please contact Technical Support for details.

For further details relating to the operation of specific interfaces, please refer to the Interface Description Manual.

## **SERVICING THE VALIDATOR**

### **CLEANING THE VALIDATOR NOTE PATH:**

#### **Equipment Required**

Cotton Swab or lint free cloth.

Cleaning solution.

A mix of Water and up to 50% Isopropyl Alcohol is recommended.

(**DO NOT** use more than 50% Isopropyl alcohol)

(**NEVER** use cleaning agents such as “Amberclens” on this product as the unit may be severely damaged)

#### **Procedure;**

**Anti-Static Precautions should be observed when cleaning validator head.**

1. Ensure the supply to the validator is switched OFF.
2. Disconnect external cables attached to the left side of validator head.
3. Move the two latches inwards to unlatch and then gently pivot top section backwards to open.
4. Using the Cotton swab or cloth dipped in the cleaning solution – carefully clean all sensors and plastic windows using light force only.
5. Continue with swab etc to clean note path, all rollers and belts (to advance belts manually rotate the drive gear at rear of unit).
6. Use an additional swab or cloth to dry area cleaned, if required.
7. Gently push down on the upper section of the reader until the latches re-engage.
8. Re-connect external cables.
9. The supply to the validator can now be switched ON.

## Jam Clearance:

1. Ensure the supply to the validator is switched OFF.
2. Disconnect external cables attached to the left side of validator head.
3. Move the two latches, on the top of the reader, inwards to unlatch and then gently pivot top section backwards to open.
4. Clear any debris from note path.
5. Re-assemble unit.



GBA HR1 in open position for cleaning and Jam Clearance.



## CALIBRATION PROCEDURE

### Equipment Required;

Stylus with small tip (for switching dip-switch)  
Calibration Paper (Thick & Thin)

### Procedure;

#### Anti-Static Precautions should be observed

1. Clean Validator Bill path.
2. The GBA HR1 **MUST** be powered up for a minimum of 15 minutes before carrying out the Calibration procedure.
3. Locate Dip-switch - visible through the top cover window, next to diagnostic LED.
4. Close switch 1 - Dip 1 (ON).
5. Insert the first sheet of clean calibration paper (Thin).
6. Paper is drawn in fully and then returned approximately 30mm (level with the note guide). It will be held here for approx. 3 seconds and then rejected in one smooth movement. If paper is rejected in three movements, switch off Dip-switch 1, cycle power to the reader and start from point 2.
7. After thin paper is rejected insert the second (Thick) sheet of Calibration paper. Paper is held for a very short period of time but does not fully enter the validator. The paper should be rejected in one smooth movement, if paper is rejected in three movements, switch off Dip-switch 1, cycle power to the reader and start from point 2.
8. Switch off Dip-switch 1. If the motor runs three times after moving the switch, cycle power to the reader and start from point 2. If not, power down the reader.
9. Power up the GBA HR1.
10. Calibration is complete.

**NB. The GBA HR1 is factory calibrated and will require re-calibration after the on-board EPROM has been changed. In general re-calibration of the unit should be carried out once every 6 months in normal conditions. When the note acceptor is located in areas that are particularly smoke filled or dusty, re-calibration should be carried out more frequently.**

## CALIBRATION PROCEDURE USING THE GBA HR1 COMPATIBLE GBA TALK DIAGNOSTICS SOFTWARE

**NB for full instructions on the GBATalk software package refer to the GBATalk Manual.**

1. Clean Validator Bill path
2. Apply power to the Validator and connect it to a PC running the Talk software. This is done utilising the AstroSystems diagnostic harness.
3. Press upload data button to confirm connection.
4. The GBA HR1 **MUST** be powered up for a minimum of 15 minutes before carrying out Calibration procedure.
5. Click on Calibrate button and follow on screen prompts.
6. Any errors will be notified to the user.
7. If errors occur, restart the GBA HR1 and start from point 3.

## CONFIGURATION PROCEDURE – Programming Card

### Equipment Required;

Stylus with small tip (for switching dip-switch)

Program Card. (PC software is available to print these cards<sup>1</sup>. Please consult your local sales office)

### Procedure;

#### Anti-Static Precautions should be observed

1. Dip-switch is visible through the top cover window.
2. Close switch 1 - Dip 1 (ON).
3. Insert the Program Card into the reader.
4. If card is read and rejected in one smooth movement, then motor continues to run for a short period, configuration is successful. If paper is rejected in three movements, insert paper a second time. If paper is still not accepted switch off Dip-switch 1, power down the unit and start from point 1.
5. After successful configuration, switch off Dip-switch 1 and power down the GBA HR1.
6. Power up the GBA HR1.
7. Configuration is complete.

#### Note:

1. Programming Card Software Version 2.00 or greater is required for ccTalk Key Reset
2. Please ensure the programming card has been printed on a high quality printer with good solid black lines on the card.

## CONFIGURATION PROCEDURE – GBATalk PC software

### Product Options:

All of the options below can be set using the GBATalk program on PC or with the Program card facility. Two kinds of program card are available. Firstly a card to set all options (all options must be specified) and secondly individual, specific option, cards that will set only security level, ccTalk® Encryption Key, Note enable / disable or the use of the magnetic head facility.

**Security:**      Selectable from four levels:

- (a) **Low**            For use in applications which are not at all security sensitive and require maximum acceptance rate.
- (b) **Standard**    Normal security level for non-Gaming applications. Target acceptance levels normally 95%+
- (c) **High**            Normal Security level for Gaming / AWP applications
- (d) **Highest**        Special security level normally reserved for particular applications

**Default is Standard (b) security**, as it offers the optimum combination between security and note acceptance.

### Use Magnetic Sensor (firmware 0216 onwards)

Selectable for units fitted with magnetic reader head, in combination with software containing "C" denotation, e.g., G99C0236.164.

## Stacker:

The GBA HR1 can be set for use with the following stacker options however, to drive a stacker the GBA HR1 will require additional on board components to be fitted:

- (1) Stackerless
- (2) Vertical Vault
- (3) USV/DSV (compact or standard vertical stacker)
- (4) Horizontal Vault
- (5) WGBA
- (6) HLRC
- (7) Option not compatible with
- (8) Mechanical Anti String Gate (please refer to TBA0003 for further details)

## Interface:

The HR1 can be set for use with the following interfaces:

- (1) Mars® Serial / Pulse
- (2) Parallel
- (3) RS232
- (4) MDB
- (5) ccTalk® Non Encrypted<sup>1</sup>
- (6) ccTalk® Encrypted<sup>1</sup>
- (7) Parallel XT
- (8) B Link
- (9) Parallel Binary
- (10) Smiley Secure Protocol (SSP)

Definitions of the above can be found in the Interface Description Manual.

### ccTalk® Encryption Key Reset: (Firmware 0230 onwards)

Should a validator require replacing in a ccTalk® application, the Encryption key will require resetting to the default in both the host machine and the note validator. This is achieved, on the note validator, by use of the ccTalk Encryption Key Reset Programming Card using the procedure described above, in "Configuration Procedure". For resetting the host machine please refer to the machine user guide.

For firmware's prior to 0230 the encryption key reset is performed via the CcTalk emulator tool.

### Escrow Time out period (Parallel modes only):

This option enables the Escrow time out period to be set in 1-second intervals between 1 and 255 seconds. **Please Note:** The standard escrow time is 26 seconds. Adjust with care! The host machine must be designed to work with any other time selected. Please contact Technical support for more details.

**Low Power Mode:** In this mode the quiescent current drawn by the unit is reduced by:

- (a) The motor power up check is disabled.
- (b) The sensors are turned off after a note is validated.

This mode is designed to enable the GBA HR1 to be used in battery applications.

---

<sup>1</sup> Note: ccTalk interface requires the use of a dedicated interface harness. Please contact your distributor or AstroSystems Ltd. for details.

## **CHANGING AN EPROM**

### **Equipment Required;**

EPROM removal Tool.

### **Procedure;**

**Anti-Static Precautions should be observed when handling or changing an EPROM.**

1. Ensure the supply to the validator is switched OFF.
2. Remove the top plate.
3. The EPROM is now visible adjacent to the back of the unit.
4. Carefully remove the EPROM using the EPROM removal Tool.
5. (Hold board down adjacent to the EPROM socket when removing the EPROM to avoid stressing the mounting).
6. Insert new EPROM with pin 1 to pin 1 of the socket. Both the EPROM and socket have a small dimple in the end to denote the location of Pin 1.
7. The power to the validator may now be switched back on.
8. Calibrate the validator (see calibration procedure)
9. Replace the top plate.

## **FLASH DOWNLOAD REPROGRAMMING**

### **Equipment Required;**

GBATalk PC software

Bootstrap Harness

Stylus with small tip (for switching dip-switch)

Diagnostic Harness

### **Procedure;**

**Anti-Static Precautions should be observed when Handling or changing an EPROM.**

**Unit must be fitted with a FLASH memory device.**

1. Ensure the supply to the validator is switched OFF.
2. Locate Dip-switch - visible through the top cover window, next to diagnostic LED.
3. Close switch Dip 2 (OFF).
4. Connect the validator to a PC running GBATalk software. This is done utilising the AstroSystems diagnostic harness.
5. Apply power to the validator.
6. Under the Bootstrap tab of the GBATalk software, Open New Dataset File and select Reprogram Validator.
7. The program will download all software and firmware to the validator. During this process the LED will rapidly alternate between Green and Red. Upon completion the LED will revert to a solid Green state.
8. Once the process is complete it is necessary to reset Dip 2 to the ON position, and restart the validator.

If the reprogramming is unsuccessful then the diagnostic LED will flash 3 times signifying an error code, please see section below (Error codes on master) for error codes.

## UNIT TO UNIT CLONING









It is possible to download software, firmware and configuration information from one GBA HR1 unit (**Master**) to a second GBA HR1 unit (**Slave**). This process is known as “Cloning”.

### **The Cloning Process:**

1. To start the process, the slave must be started in bootstrap mode, this is achieved by setting DIP switch 2 “**OFF**”.
2. The two validators must be connected together before power is applied. The diagnostic LED on the Master will start off **green**.
3. Once power is connected, switch Dip 1 to the “**ON**” position on the Master.
4. The core bootstrap program should load automatically onto the Slave. Once the core program is received the diagnostic LED on the Slave will turn **red**.
5. Once the Master has transmitted the Extended bootstrap program correctly the diagnostic LED on the Slave will turn **green**. The Master can then interrogate the slave to determine if there is a FLASH device fitted and also determine the Slave firmware version.
6. If the Master receives no acknowledgement from the Slave at this point it will cease the process and signal failure via the LED error codes.
7. If there is no supported FLASH device detected the Master will also signal failure via the LED error codes.
8. If the Master has a newer firmware version, then it will be downloaded onto the Slave first. The Slave Diagnostic LED will flash between **red** and **green** very quickly.
9. This will be followed by the dataset.
10. Finally the Master will transmit the notes enabled and security to the Slave. The following settings will not be affected: Serial number, Calibration data, ccTalk ID or encryption code, Stacker type and Interface type.
11. To end the process power off both units and return dip switches to their original state.

### Error Codes on the Master

These error codes will be signalled using the Diagnostic LED (**Green** or **Red**). Each code comprises 3 flashes. Each flash lasts about 0.5 seconds, starting with “off”. E.g. off, **red**, off, **red**, off, **green**.

<b>Error Condition</b>	<b>Code (3 Flashes)</b>
No response from Slave	
Not recognised FLASH device on Slave	
Failure while downloading bootstrap program	
Failure while downloading EEPROM settings	
Failure while checking slave firmware revision	
Failure while downloading firmware	
Failure while downloading dataset	
Successful download	

## **CHANGING NOTE GUIDE PLATES:**

(To accommodate alternative currencies)

Illuminated runway Note Guides are fitted as standard to GBA HR1 products.

An illuminated runway note guide is available in UK, Canadian, US and European form. Please consult factory for details and changing instructions.

Illuminated note guide connections:

Pin 1 (Black Wire)	0Volts
Pin 2 (Red Wire)	12VDC
Pin 3 (Yellow Wire)	Control

Control < 0.5VDC =	Off
Control > 3VDC =	On

## **OPTICAL ANTI STRING GATE (OASG):**

### **Introduction:**

The OASG is a key component of the GBA HR1 security system. The sensor detects strings, tape or other foreign objects behind the note being validated. Should any objects be detected then the note is rejected. Options exist for the unit to be disabled if a preset limit of consecutive string attempts is detected.

### **Operation:**

#### **General:**

Once the validator has completed the validation process and is satisfied the note is genuine; the note is moved from the escrow position, such that, the rear of the note is clear of the OASG sensor. A reading is taken and if it is within limits the note is transported to the cashbox and credit given. If the reading is outside limits the note is rejected.

Eight variables can be set in EEPROM memory to control the OASG operation.

- 1) No. of String Attempts Before OASG Locks Out
- 2) OASG Lock Out Period
- 3) OASG Recalibration Period (F/W 0230 onwards)
- 4) OASG Sensitivity
- 5) OASG Foreign Object Check
- 6) Note Jam Detect Limit
- 7) Note Returned Prior to Lock Out
- 8) Enable 2 Note Return check

### **Calibration:**

When the unit is calibrated the OASG is set up to read 176 on pre 0230 F/Ws or 200 on 0230 F/W and above. The Ambient reading is stored.

For F/W 0230 onwards an option is available to recalibrate the OASG periodically during idle times. If the validator is in a jam or alarm condition then recalibration does not occur.

### **Soft options:**

The following options can be set using the GBAService set up program. Options 1, 2, 5 and 8 (above) can also be set using the Programming Sheet utility.

#### **1) String Attempts Before OASG Locks Out:**

This option can be set from 0 to 255 and limits the number of successive OASG rejects that will be allowed. When the set value is reached the validator will issue an alarm signal (according to the interface in use). Additionally the validator will lock out (disable) for "x" minutes, where "x" is the setting of the "OASG Lock Out Period".

**Note:** *This option can be turned off by setting this feature to zero.*

**Default setting is 0 attempts**, as this feature is only applicable in a limited number of cases, where a specific security incident has been reported.



## 2) **OASG lock out period.**

This option can be set from 0 to 255 and determines the time (in minutes) that the validator is disabled, following the detection of the set number of successive OASG rejects. If this option is set to zero, and the “String attempts before OASG lock out” is set to 1 or more, the unit will not lock out when the limit is reached, however it will return the note and give an alarm signal.

**Default setting is 5 minutes**, as this acts as an effective deterrent to the persistent fraudster, whilst minimising disruption to the legitimate user.

## 3) **OASG Recalibration Period.**

This option can be set from 0 to 255 and determines the time (in minutes) between OASG calibrations. This will ensure that long-term degradation of the sensors is compensated for. If this option is set to 0 then no recalibration will occur.

**Default setting is 10 minutes**; this offers a regular automatic response to changes in environmental conditions.

## 4) **OASG Sensitivity.**

This option can be set to Low, Standard, High or Disabled. Disabled removes operation of the OASG for string checks.

**Default setting is Low for Stackerless applications**, as this provides best combination of security and acceptance

**Default setting is Disabled for Stacker applications**, as this type of unit offers inherently higher levels of security due the physical operation of the stacking process.

## 5) **OASG Foreign Object Check.**

This option checks for the insertion of foreign objects into the bill path, if such an event is detected then the unit will lock out until the object is removed.

**Default setting is OFF** as this feature is only applicable in a limited number of cases, where a specific security incident has been reported.

## 6) **Note Jam Detect Limit.**

This option sets the change in conditions required to activate a “Note Jam” state. This limit should not be altered unless specifically advised by ASL.

**Default setting is 40**, as it has been calculated to be the optimum value for all applications.

## 7) **Note Returned Prior to Lock Out.**

This option specifies whether a note should be returned to the customer (ON) or held at the rear of the acceptor (OFF), if the “String attempts before OASG lock’s out” value is reached

**Default setting ON**, as this ensures that the note is returned to the customer, should a fault be detected.

## 8) **Enable “two note return check”**

This option is used to activate a security feature to detect specific fraud attempts, please contact ASL for more information.



# GBA Global Bill Acceptors      GBA HR1 Operation Manual

**Default setting is OFF**, as this feature is only applicable in a limited number of cases, where a specific security incident has been reported.

## **GBA HR1 DEFAULT SETTING GUIDELINES:**

**Note:** The GBA HR1 can be configured in many ways allowing the user to customize the unit to their specific requirements. The configurations listed below are our default settings for this product within set applications.

No	Options	Stacker less units			Stacker units	
		Default	Car Wash	Windowed Notes	Stacker	MASG
1	String attempts before OASG lock's out.	0	0	0	0	0
2	OASG lock out period	5	5	5	5	5
3	OASG Recalibration period (minutes)	10	10	10	10	10
4	OASG sensitivity	Low	Low	Low	Low	Low
5	OASG Foreign object check	No	No	No	No	No
6	Note jam detect limit	40	40	40	40	40
7	Note returned prior to lock out	Yes	Yes	Yes	Yes	Yes
8	Enable 2 note return check	No	No	No	No	No
9	Discrimination security	Std	Low	Std	Std	Std

**Note:** *Discrimination Security is explained further under the heading "security" within the "Configuration Procedure – GBATalk PC software" subject above.*

**DIAGNOSTICS:**

**Introduction:**

The GBA HR1 is fitted with a micro board having the facility to communicate validator status by the use of a bi-colour (Red / Green) LED. The following functionality describes the operation of the LED when fitted with firmware Version 0230 onwards.

The LED is visible through the calibration switch hole on the top cover.

**LED Functionality:**

The LED communicates validator status. This enables enhanced diagnostics for the user and for AstroSystems personnel when assisting customers over the phone or by email.

**Normal Run Mode:**

The LED will be permanently Green (solid on)

If a note is rejected a flash code is given (Green LED Flashed off):

If the note is rejected due to:	<u>No of flashes (led goes off)</u>
Unrecognised note	1
OASG Reject	2
Returned (due to escrow or SW inhibit)	3
Note slip during validation	4
Potential Note Cross-Validation	5

**Validator Inhibited by Host:**

If the host inhibits the unit then the green LED will flash slowly (rate 0.5Hz, approx 1 sec on / 1 sec off).

**Fault Conditions:**

Indicated by turning the LED Red.

<u>Fault</u>	<u>LED State</u>
Stacker full or Jam	Solid Red LED
Cashbox not present	Slow Flashing Red (approx. 0.5Hz)
OASG Lock out	Fast Flashing Red (approx. 1 Hz)



**Order of precedence of Error Codes:**

There may be situations where more than one fault/operating condition is applicable, in which case the order of precedence of displaying the codes is as follows:

- |                                |                     |
|--------------------------------|---------------------|
| 1. Note Jam / Stacker Full     | (solid red)         |
| 2. Anti-String Gate Lock-out   | (fast flash red)    |
| 3. Calibration Mode            | (flash red / green) |
| 4. Cash Box Missing            | (slow flash red)    |
| 5. Validator Master Inhibit On | (slow flash green)  |













































## Calibration Mode

When the calibration switch (SW1) is in the “on” position and the unit is powered up, the LED will flash the Firmware revision level (see below) followed by an alternate Red / Green (1Hz) flash to indicate the unit has entered calibration mode.

When the calibration switch is turned on while the power is on, then calibration mode (  /  (1Hz) alternating flash) is entered directly.









Should calibration fail then the following codes should be given after the switch 1 is returned to the off position:

1 second off time then:

<u>Cause</u>	<u>Flash</u>
IL Fail	   
IR Fail	   
VL Fail	   
VR Fail	   
UR Fail	   
UL Fail	   
DR Fail	   
DL Fail	   
OAS Fail	   
Mag Fail	   
Calibration Aborted	   

Then 1 second off – the unit will then go back to run time status indication.

## Other Faults:

EEPROM checksum error	   
External RAM error	   

### Firmware Revision Level:

The validator will signal the current firmware version after the unit is switched on and the Calibration Switch is turned on\*, as follows:

- Red LED will flash as a delimiter before each character.
- Green LED will flash the individual numbers of the revision code.
- There is no red flash at the end, but there is a one second delay before the Green / Red flash LED comes on to indicate "Calibration" mode status.
- For zero, there will just be 2 consecutive red flashes.

If the cal switch is returned to its "off" position during the display of the revision level, the display will continue and the validator will enter normal run mode following the 1 second delay at the end

### Example:

When the validator signals 0224:

The LED will flash...



\* Note Firmware version 0227 indicated revision on power up, regardless of the status of the calibration switch.

Firmware version 0227 would not display revision if the validator were in low power mode.

**Product Bulletin**  
**Compact Bezel Mono Bracket Kit**

PART No: ASY-M-130017

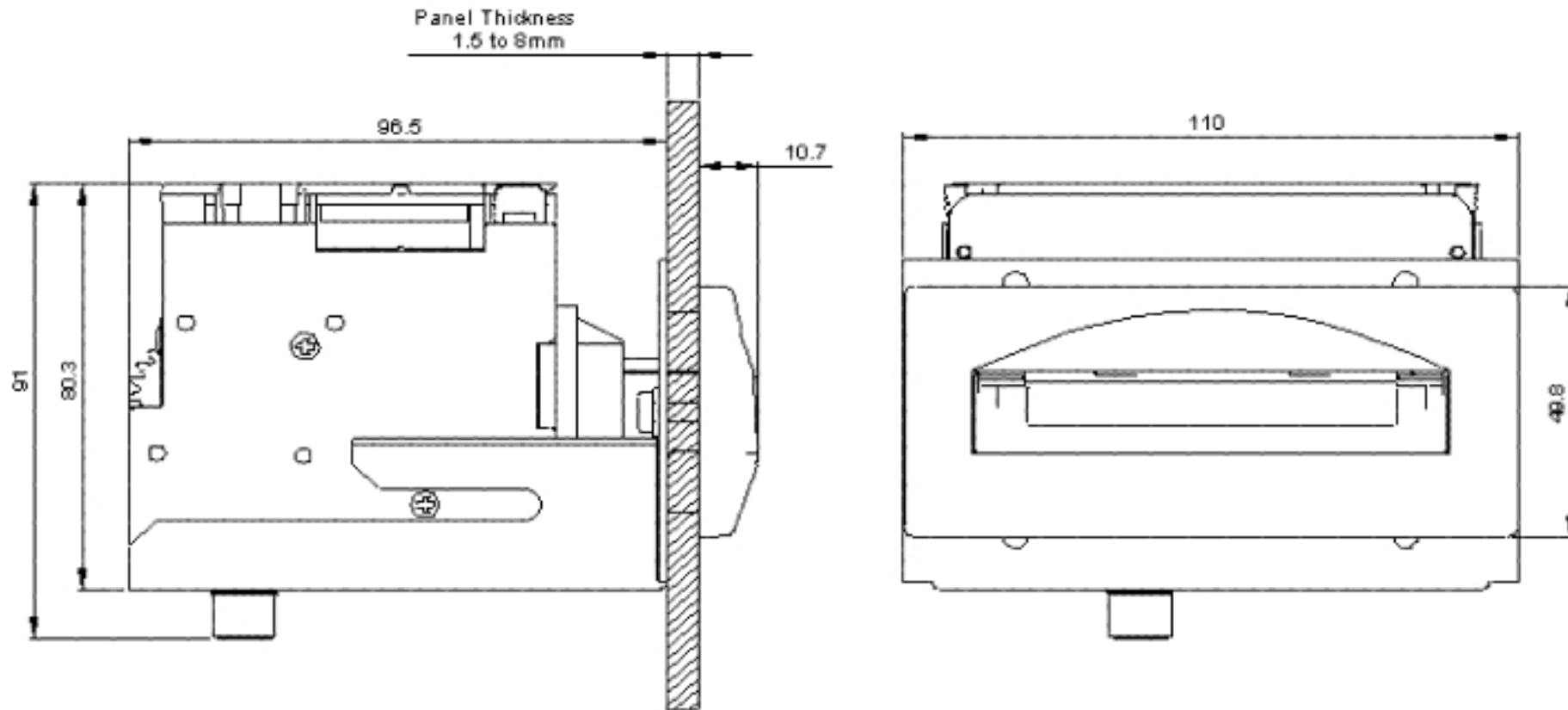

Doc No. PB-ASY-M-130017  
Page 2 of 2  
Rev 1.0a, Compact Mono Kit  
This drawing is the property of Microsystem Controls and is to be used only for the specific application and equipment for which it was prepared. It is not to be reproduced or used in any other manner without the prior written consent of Microsystem Controls.

Microsystem Controls  
29 January 2004

**Product Bulletin**  
**Standard Bezel Mono Bracket Kit**  
PART No: ASY-M-130016

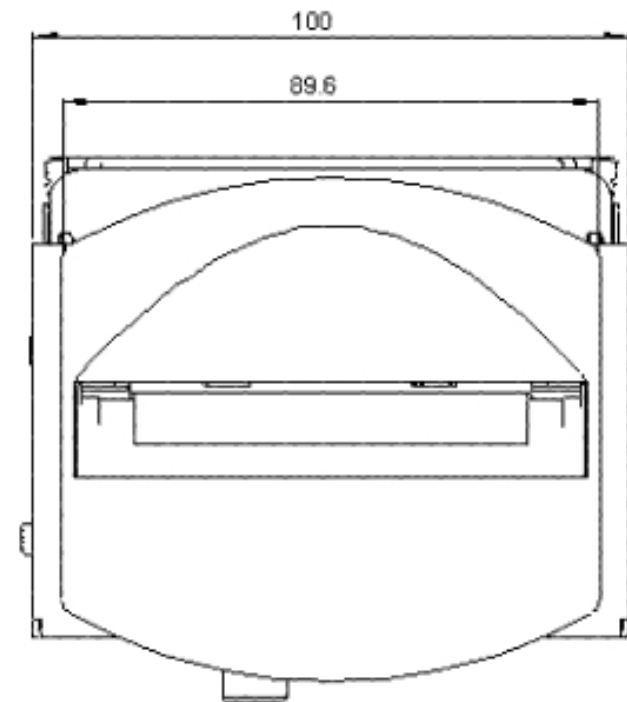
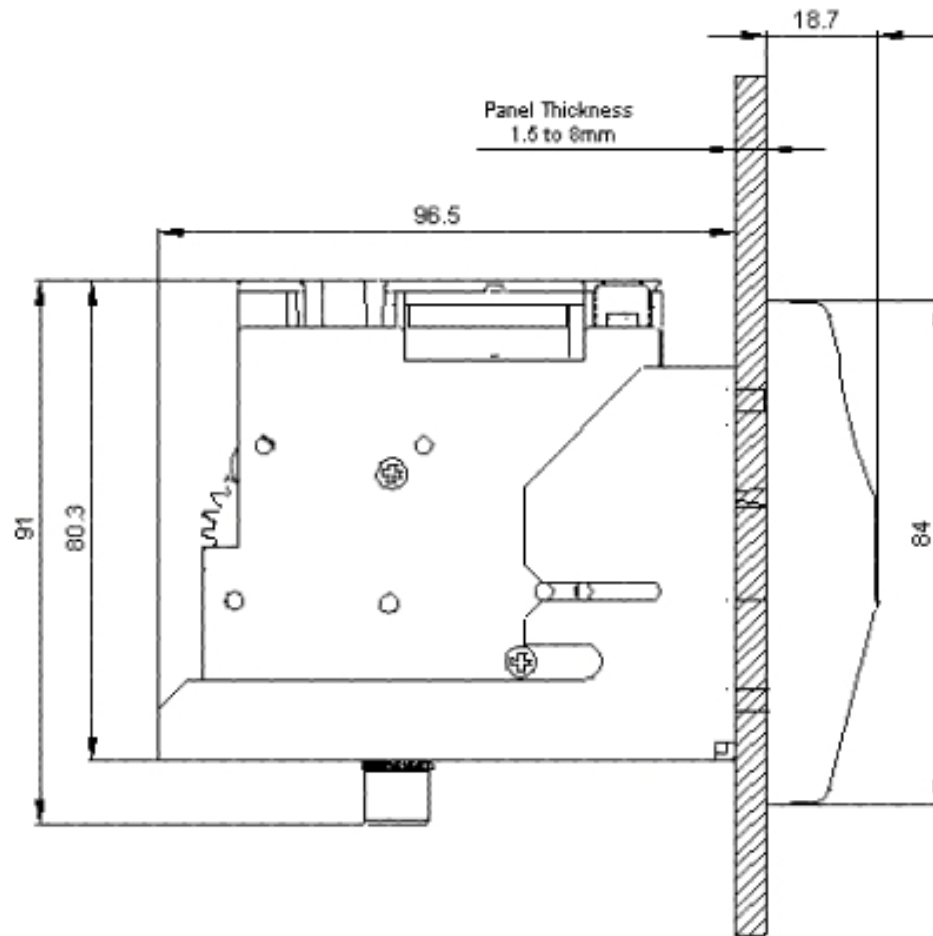

Dwg No: PB-ASYM-130016

Page 22

Rev File: Standard Mono Bezel

This drawing is for use on the colour assembly that is a copy of the original. It is confidential property of GBA and is not to be used or reproduced without the prior written consent of the company.

Metro Systems Corporation  
23 January 2005

troSystems Ltd  
January 2005  
GBA HR1 Op Manual V1.42

Revision	Date	Created By	Approved by	Comments
1.0	14 Jan 2003	Andy Walsh	JB	Creation of new manual
1.01	25 Feb 2003	Andy Walsh		ccTalk update
1.24	02 Oct 2003	Steve Priest		Diagnostic LED codes updated
1.30	22.May.2004	Steve Priest		Update general information and new features.
1.41	08 Dec 2004	Steve Priest		Update to include Horizon validator.
1.42	018Jan 2005	Steve Priest		Include details of Default setting guidelines, Mechanical ASG option and update name to HR1 validator

**Contacts:**

AstroSystems Ltd  
 1 The Quadrangle  
 Grove Technology Park  
 Wantage  
 Oxon. OX12 9FA  
 U.K.

Tel: +44 (0) 1235 772201  
 Fax: +44 (0) 1235 772202  
 E-Mail: [sales@astrosystems.co.uk](mailto:sales@astrosystems.co.uk)

AstroSystems Inc.  
 4210 Production Court  
 Las Vegas  
 Nv 89115  
 USA.

Tel: +1 702 643 1600  
 Fax: +1 702 643 1717  
 E-Mail: [sales@astrosystemsinc.com](mailto:sales@astrosystemsinc.com)

Microsystem Controls Pty Ltd  
 Unit 2 Ground Floor  
 63-85 Turner Street  
 Port Melbourne  
 Victoria 3207  
 Australia

Tel: +613 9646 6446  
 Fax: +613 9646 6447  
 E-Mail: [sales@microcoin.com](mailto:sales@microcoin.com)

AstroSystems (Far East) Ltd.  
 2/F 28 Hung to Road  
 Kwun Tong  
 Kowloon  
 Hong Kong

Tel: +852 2342 6123  
 Fax: +852 2342 6105  
 E-Mail: [ASF.Sales@astrotech.com.hk](mailto:ASF.Sales@astrotech.com.hk)